



INSTALLATION INSTRUCTIONS

15003

LOWERING COILOVER

300 W. Pontiac Way Clovis, CA 93612

toll free: 1-800-445-3767

web: www.belltech.com

2019+ GM1500 2WD/4WD

Thank you for being selective enough to choose our high quality BELLTECH PRODUCT. We have spent many hours developing our line of products so that you will receive maximum performance with minimum difficulty during installation

Note: Confirm that all of the hardware listed in the parts list is in the kit. **Do not** begin installation if any part is missing. Read the instructions thoroughly before beginning this installation.

Warning: DO NOT work under a vehicle supported by only a jack. Place support stands securely under the vehicle in the manufacturer's specified locations unless otherwise instructed.

Warning: DO NOT drive vehicle until all work has been completed and checked. Torque all hardware to specified values.

Reminder: Proper use of safety equipment and eye/face/hand protection is absolutely necessary when using these tools to perform procedures!

Note: It is very helpful to have an assistant available during installation.

Exceptional Customer Experience Guarantee:

STOP! We strive for an exceptional experience for all of our valued customers. If, for any reason, you need assistance with your Belltech products, please do not return the products to the store or website you purchased from. Please call our dedicated experts at

(1-800-445-3767) from 6am to 5pm PST.

RECOMMENDED TOOLS

- Properly rated floor jack and support stands
- Combination wrench set
- Ratcheting socket wrench and socket set
- Safety glasses
- Torque wrench
- Wheel chocks
- Tape measure
- Marking pen
- Strut Spring Compressor



DIFFICULTY:



INSTALLATION TIME: 2-4hrs + Alignment

KIT INSTALLATION

WE RECOMMEND that a qualified mechanic, at a properly equipped facility, perform this installation.

WE RECOMMEND that the installation be performed on a firm, flat, and level surface such as seasoned asphalt or concrete.

The use of safe and proper equipment is very important!

KIT PRERPERATION

- a) Before beginning the install process, measure the hub to fender heights for your vehicle so you can compare the resulting height to the original. Measure vertically from the center of the wheel to the inner edge of the fender. Record results here.

LF: _____ RF: _____

LR: _____ RR: _____

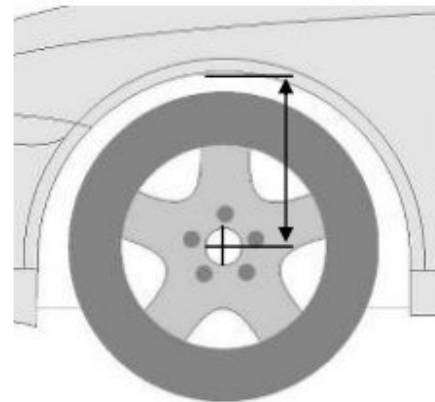
**1) JACKING, SUPPORTING AND PREPARING THE VEHICLE**

- a) Block the rear wheels of the vehicle with appropriate wheel chocks. Make sure the vehicle's transmission is in "PARK" (automatic) or 1st gear (manual). Activate the parking brake.
- b) Loosen, but **DO NOT REMOVE** the front wheel lug nuts.
- c) Lift the front of the vehicle off the ground using properly rated floor jack. Lift the vehicle so that the front tires are approximately 6-8 inches off the ground surface.
- d) Place support stands rated for the vehicles weight. The stands should be positioned in the factory specified locations. (Refer to owners manual). Prior to lowering the vehicle onto stands, make sure the support stands will contact the chassis. It is very important that the vehicle is properly supported to prevent any harm to ones self or to the vehicle.
- e) Lower the vehicle slowly onto the stands, checking that they properly and securely contacting the frame rails as described above before placing the vehicles weight completely on them.
- f) Remove the front wheels.

!SAFETY REMINDER!

Check for safe vehicle stability before proceeding under the vehicle to begin the following procedures. Never work under a vehicle supported by ONLY a jack. Always use properly rated support stands to support the vehicle.

2) OEM Strut Removal

- a) Locate the three mounting bolts of the strut top mount and remove the nuts using a 18mm wrench. **(Photo 1)**
- b) Locate bolts on the underside of the lower control arm that hold the strut to the lower control arm. **(Photo 2)**
- c) Remove two bottom mounting nuts of the spring/strut assembly. **(Photo 3)**
- d) Remove the mounting nuts holding the sway bar end link to the lower control arm. This will allow the lower control arm to swing down and make the removal of the strut easier. The nut will be on the underside of the lower control arm. **(Photo 4)**
- e) Push the lower control arm down to provide enough room to pull the OE strut from the vehicle.

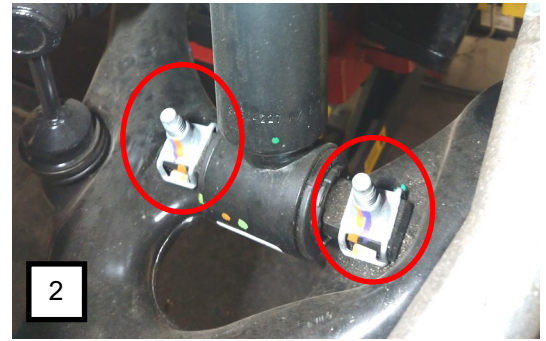
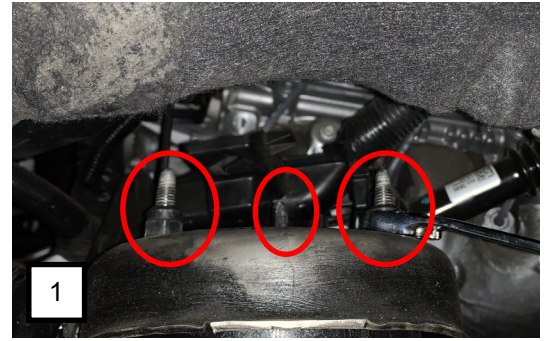

3) OEM Strut Disassembly

!CAUTION! The coil spring is held in place under extreme compression. Belltech recommends the use of a heavy duty spring compressor suitable for truck springs to perform the following steps. If unsure of your spring compressor capabilities, take your struts to a professional installer. Use caution during the following steps to avoid personal injury and/or damage to the vehicle.

- a) Mark the orientation of the strut top mount relative to the strut body with a paint pen.
- b) Mount the strut assembly into a spring compressor and compress the spring to alleviate the tension on the strut **(Photo 5)**



c) Locate the top nut of the strut assembly and loosen (**DO NOT USE AN IMPACT**) the nut with a 18mm wrench. **(Photo 6)**



d) Remove the nut and decompress the spring. **(Photo 7)**
Note: Support the strut as the spring decompresses as the strut can slide out.

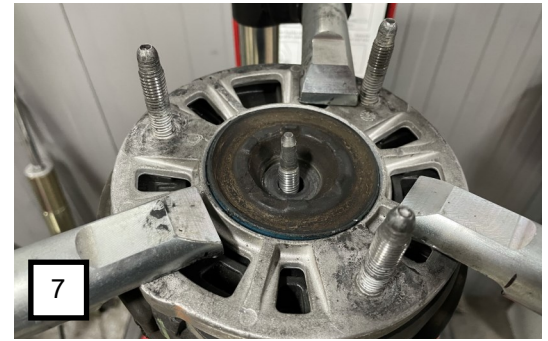

e) Remove the top mount from the spring isolator as this will be the only part reused. All other parts can be discarded. **(Photo 8)**

Note: A screwdriver or pry tool may be useful to separate the top mount from the isolator.

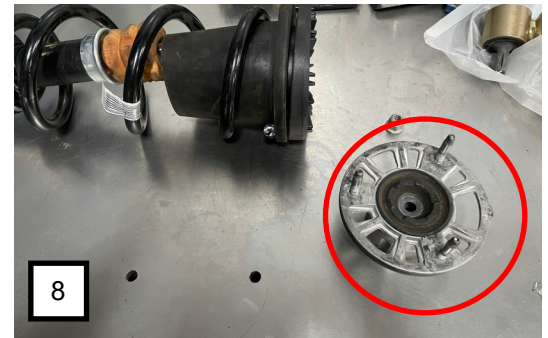

4) Coilover Assembly/Setup

a) The coilover comes as shown in **photo 9**. Remove the nylock nut from the top of the Belltech coilover.

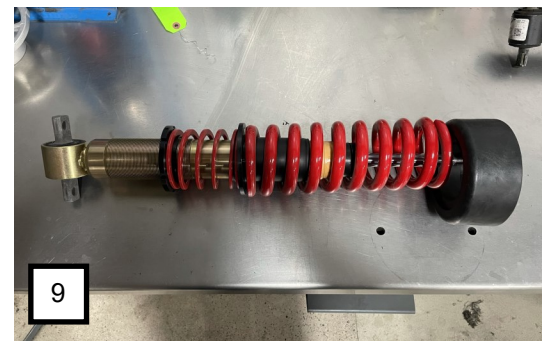

b) Using the vehicle height table below for your application, remove the main spring and slide the required packers onto the strut rod. **(Photo 10)**

Note: Ensure that the vent disk is on the strut under the dust boot. If the vent disk is not present, please notify our technical support staff as driving on the strut without this disk could cause the shock to fail.

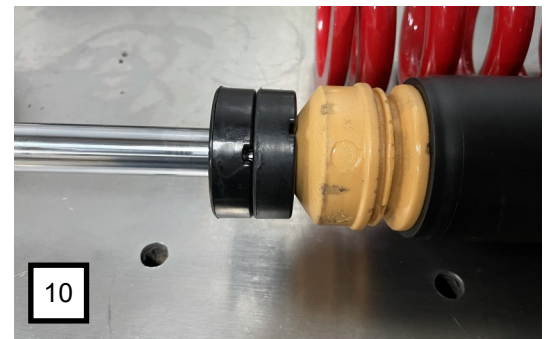

Vehicle Lowering Height Table (2WD)		
Vehicle Height	Spring Perch Height ("A" Measurement)	Packers
1" Drop	193mm	2
2" Drop	178mm	1
3" Drop	162mm	0
3.5" Drop	154mm	0

Vehicle Lowering Height Table (4WD)		
Vehicle Height	Spring Perch Height ("A" Measurement)	Packers
1" Drop	201mm	2
2" Drop	186mm	1
3" Drop	170mm	0
3.5" Drop	162mm	0

- c) Loosen the set screw in the side of the spring perch.
- d) Using the provided spanner wrench, turn the bottom spring perch to obtain the desired spring perch height measuring from the top of the perch to the center of the bushing. The spring perch height can be found using the vehicle height table below.
- e) Tighten the set screw in the side of the spring perch.

Vehicle Lowering Height Table (2WD)		
Vehicle Height	Spring Perch Height ("A" Measurement)	Packers
1" Drop	193mm	2
2" Drop	178mm	1
3" Drop	162mm	0
3.5" Drop	154mm	0

Vehicle Lowering Height Table (4WD)		
Vehicle Height	Spring Perch Height ("A" Measurement)	Packers
1" Drop	201mm	2
2" Drop	186mm	1
3" Drop	170mm	0
3.5" Drop	162mm	0

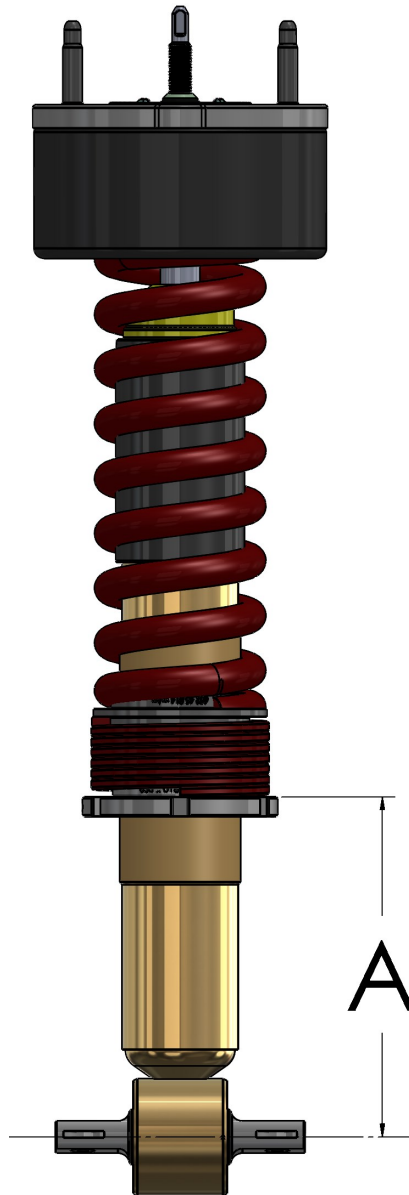

- f) Push the OE top mount into the Belltech upper spring seat. **(Photo 11)**
Note: This should require no pressure
- g) Reassemble the main spring and upper spring seat with the OE top mount onto the Belltech strut. **(Photo 12)**
- h) Using the nylock nut supplied that came on the strut, torque the nut down. Reference the OE strut markings and ensure that the top mount is in the same orientation as when disassembled from the OE strut. **(Photo 13)**

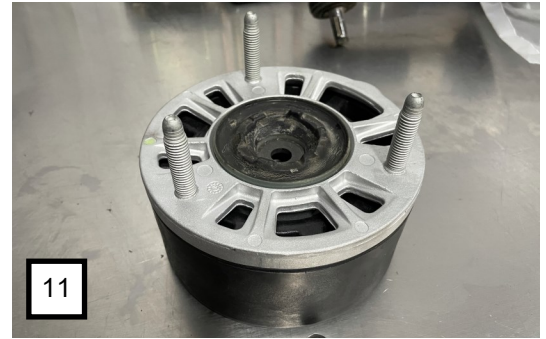

4) Coilover Installation

- a) Install the Belltech coilover into the frame strut tower. Secure the top mount with the OEM flanged nuts and torque to factory specifications. **(Photo 14)**
- b) Attach the lower strut mount to the lower control arm using the OE hardware. **(Photo 15)**
Note: Unless otherwise stated reuse the OE bottom strut clips and OE bolts.
- c) Reinstall the sway bar end link nut in reverse order of removal.



5) Finalizing the Installation

- a) Re-install the wheels and torque to OEM specifications.
- b) Check that all components and fasteners have been properly installed and torqued.
- c) Lift the vehicle and remove the support stands. Carefully lower the vehicle to the ground.
- d) Check brake hoses, cables, and other components for possible interference.
- e) Check for wheel/tire to chassis/body interference.
- f) Test-drive the vehicle in a remote location so that you can be accustomed to the revised driving characteristics and handling. Be aware that the vehicle will handle substantially different.
- g) Check all of the hardware and re-torque at intervals for the first 10, 100, and 1000 miles.

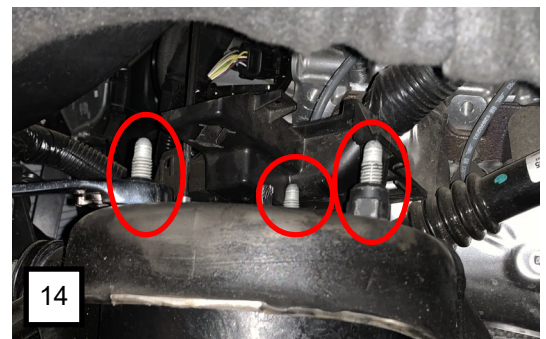

NOTE: Front end alignment is required immediately following the installation.

Component List		
P/N	ITEM DESCRIPTION	QTY
15003-100	Belltech Coilover	1
68510039	100mm Spanner Wrench	1

Component List (15003-100)		
P/N	ITEM DESCRIPTION	QTY
15003-134	Threaded Damper	1
65050018	Upper Spring Seat	1
4001-001	Helper Spring	1
65245814	Intermediate Ring	1
4935-001	15mm Packer	2
65210800	Dust Boot	1
15103-103	Upper Spring Adapter	1
15002105	Vent Disc	1
65210799	Bump Stop	1
70150-240	Linear Spring	1